

Thermakraft Industries (NZ) Ltd 11 Turin Place, Auckland P.O. Box 58-112, Greenmount, Auckland Ph: +64 9-273 3727 Fax: +64 9-273 3726 Free Phone 0800 806 595	DRAWING TITLE Opening in Framing		DATE JUNE 2005	SHEET No. W1
	DRAWN MKN	© Copyright	SCALE NTS	

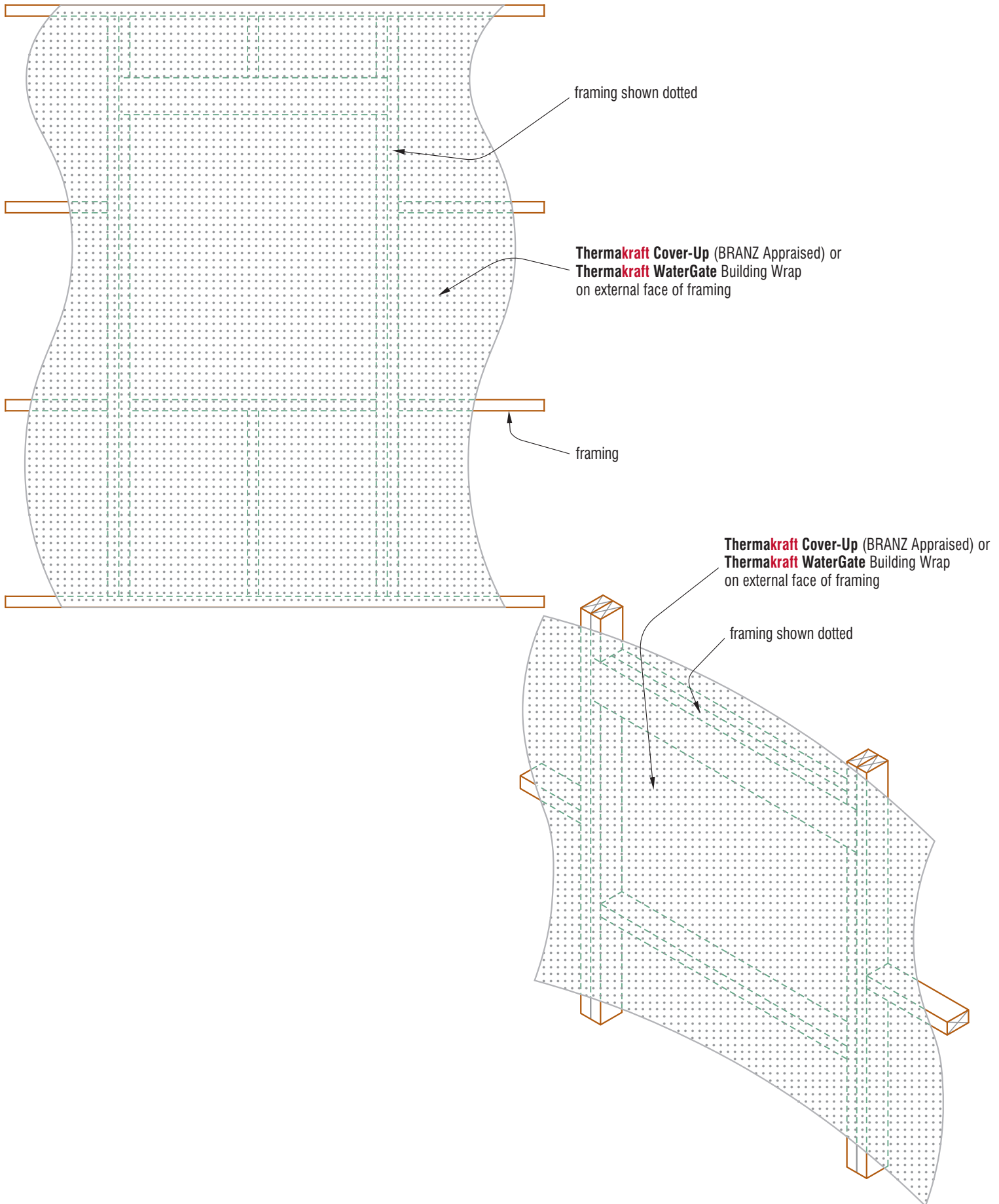

Thermakraft Industries (NZ) Ltd 11 Turin Place, Auckland P.O. Box 58-112, Greenmount, Auckland Ph: +64 9-273 3727 Fax: +64 9-273 3726 Free Phone 0800 806 595	DRAWING TITLE Building Wrap over Framing		DATE JUNE 2005	SHEET No. W2
	DRAWN MKN	© Copyright	SCALE NTS	

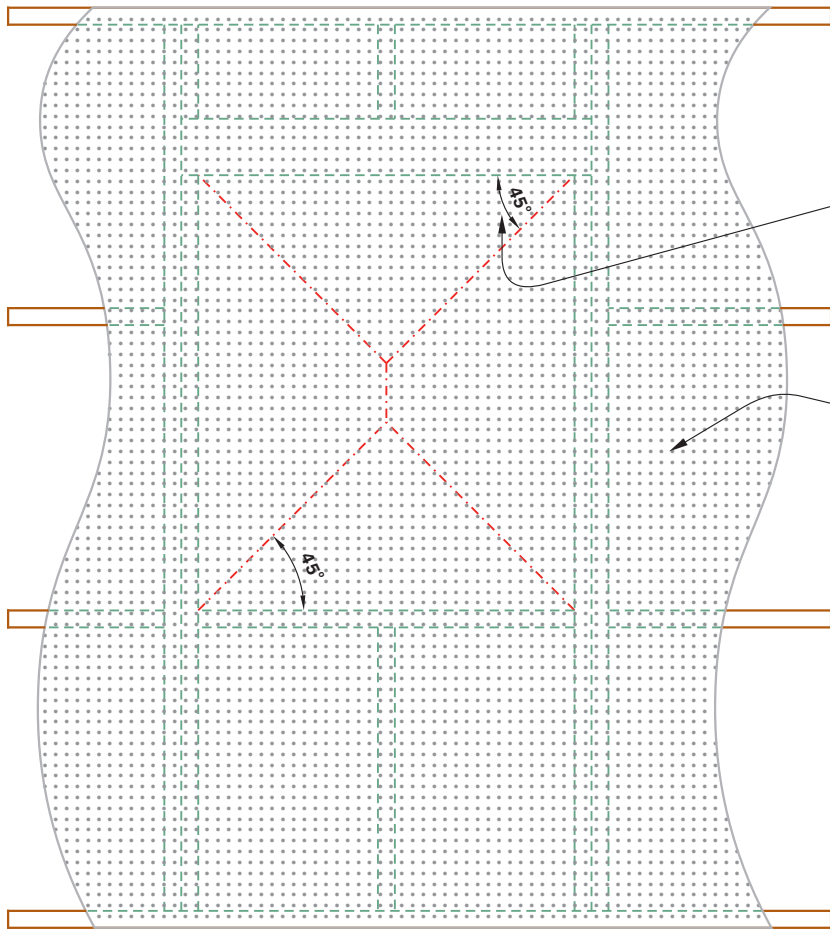

Thermakraft Cover-Up (BRANZ Appraised) or **Thermakraft WaterGate** Building Wrap to be cut at 45° to corners of openings

Thermakraft Cover-Up (BRANZ Appraised) or **Thermakraft WaterGate** Building Wrap on external face of framing

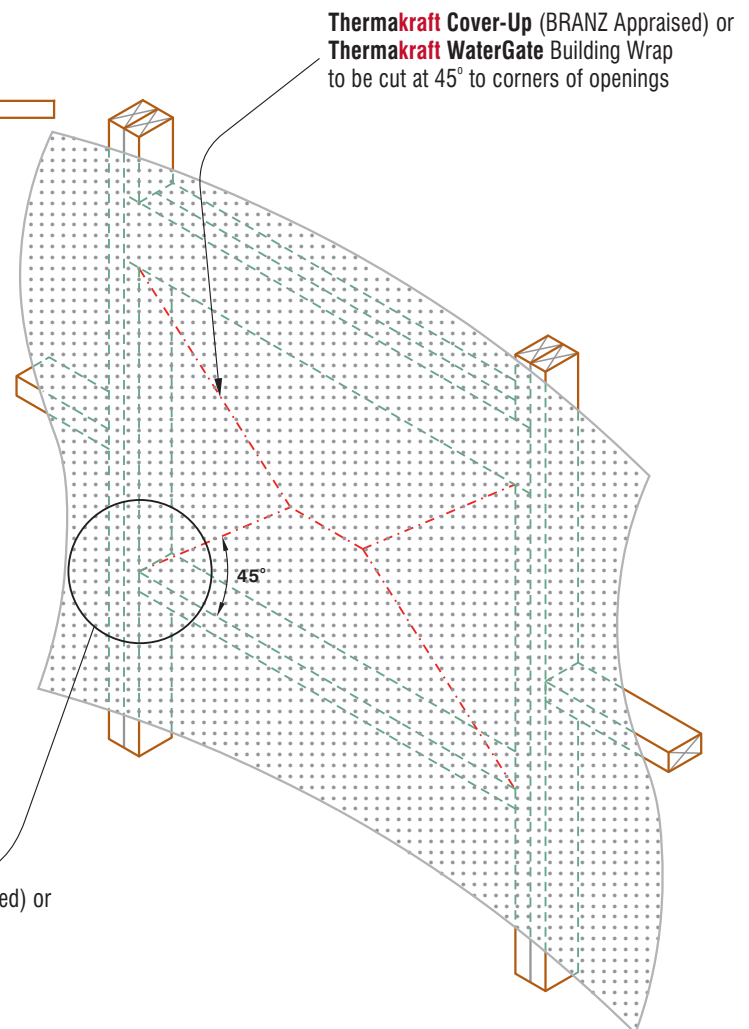

Thermakraft Cover-Up (BRANZ Appraised) or **Thermakraft WaterGate** Building Wrap to be cut at 45° to corners of openings

Thermakraft Cover-Up (BRANZ Appraised) or **Thermakraft WaterGate** Building Wrap to be cut at 45° to corners of openings

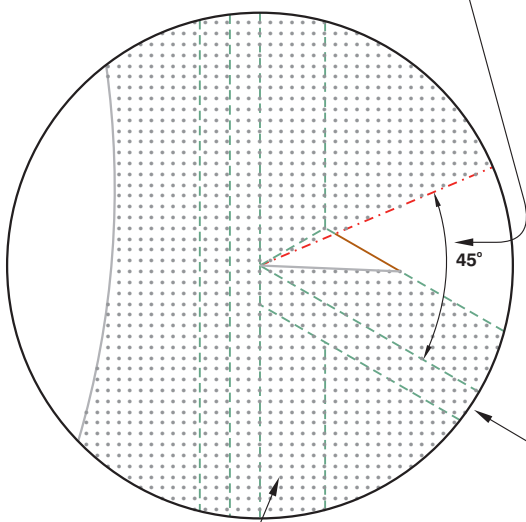

Thermakraft Cover-Up (BRANZ Appraised) or **Thermakraft WaterGate** Building Wrap fixed to external face of framing

Thermakraft Industries (NZ) Ltd 11 Turin Place, Auckland P.O. Box 58-112, Greenmount, Auckland Ph: +64 9-273 3727 Fax: +64 9-273 3726 Free Phone 0800 806 595	DRAWING TITLE		DATE	SHEET No. W3
	Cut Building Wrap at Opening		JUNE 2005	
	DRAWN MKN	© Copyright	SCALE NTS	

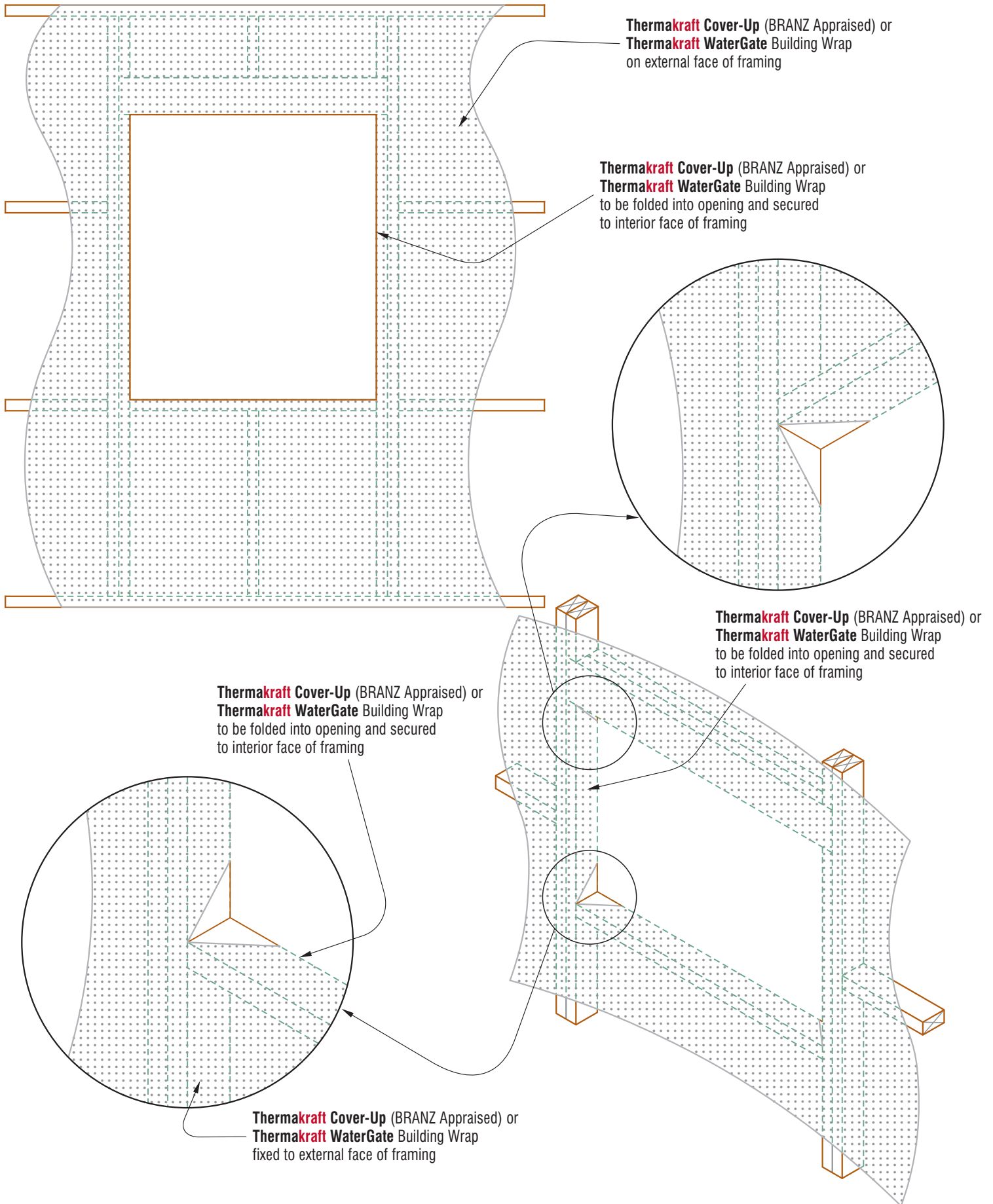

Thermakraft Industries (NZ) Ltd 11 Turin Place, Auckland P.O. Box 58-112, Greenmount, Auckland Ph: +64 9-273 3727 Fax: +64 9-273 3726 Free Phone 0800 806 595	DRAWING TITLE		DATE	SHEET No.
	Fold Building Wrap into Opening		JUNE 2005	W4
DRAWN	© Copyright		SCALE	
MKN			NTS	

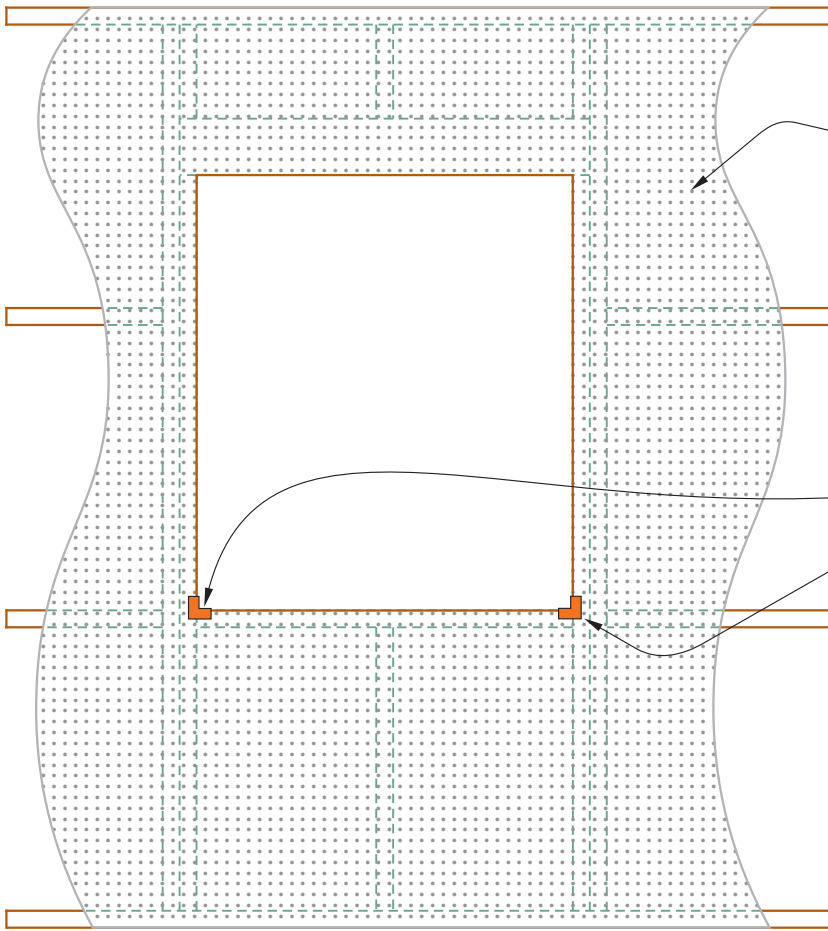

Thermakraft Cover-Up (BRANZ Appraised) or **Thermakraft WaterGate** Building Wrap on external face of framing

Thermakraft Corner Moulded Piece™
sill mould secured at both corners of opening

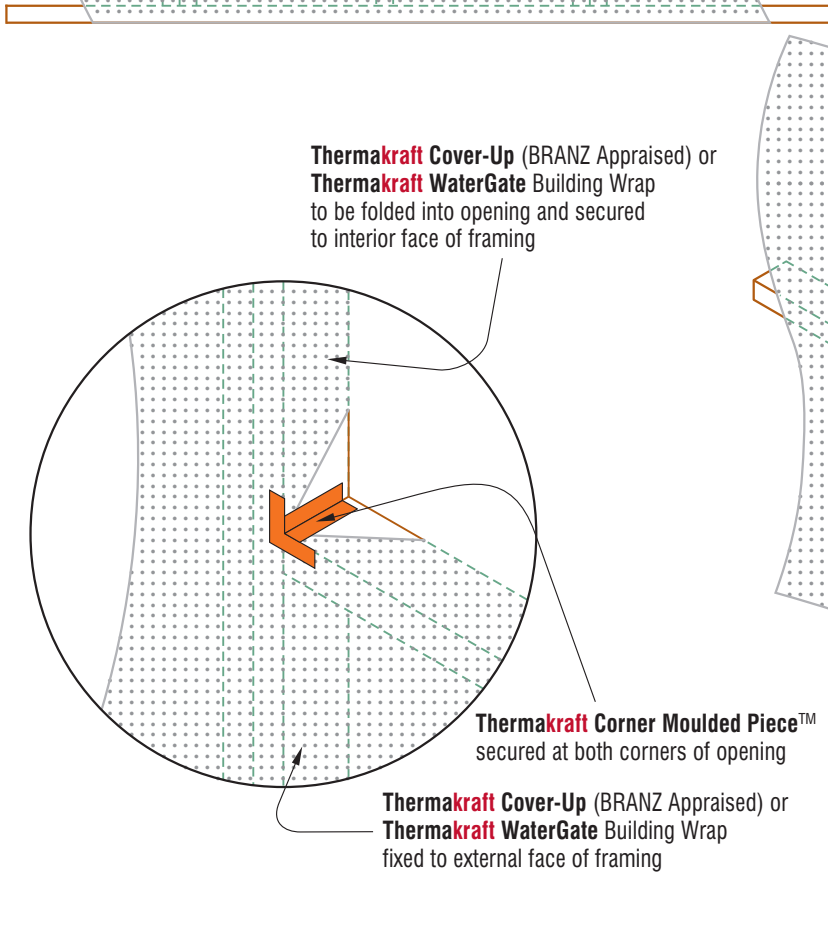

Thermakraft Cover-Up (BRANZ Appraised) or **Thermakraft WaterGate** Building Wrap to be folded into opening and secured to interior face of framing

Thermakraft Corner Moulded Piece™
secured at both corners of opening

Thermakraft Cover-Up (BRANZ Appraised) or **Thermakraft WaterGate** Building Wrap fixed to external face of framing

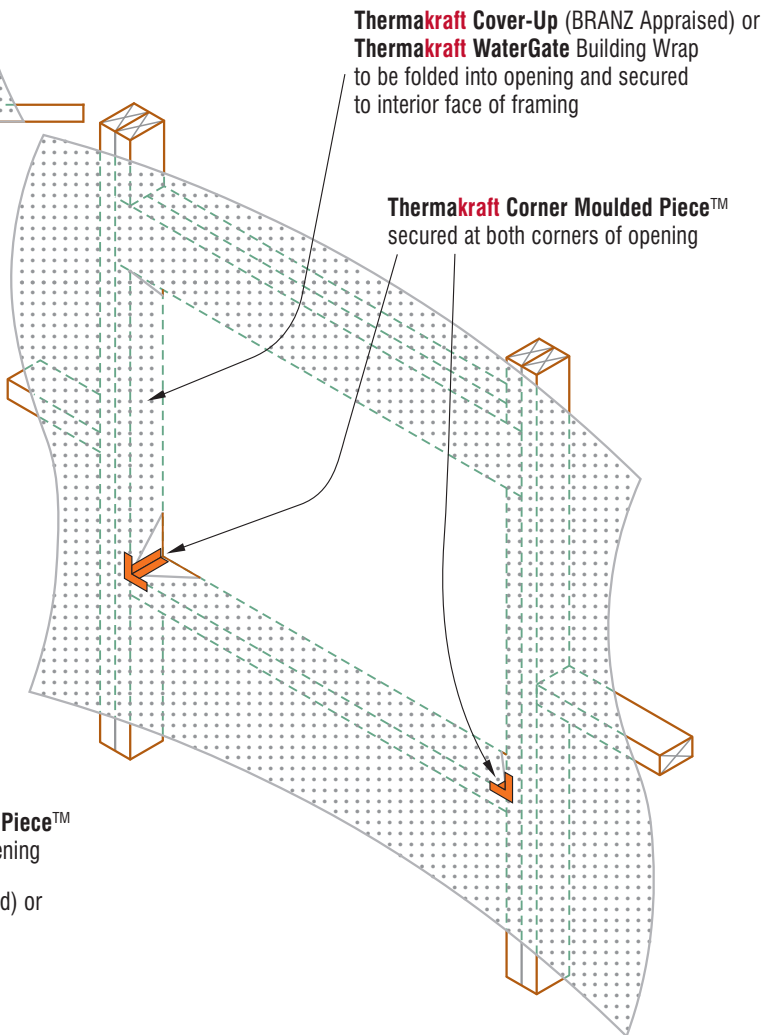

Thermakraft Cover-Up (BRANZ Appraised) or **Thermakraft WaterGate** Building Wrap to be folded into opening and secured to interior face of framing

Thermakraft Corner Moulded Piece™
secured at both corners of opening

Thermakraft Industries (NZ) Ltd 11 Turin Place, Auckland P.O. Box 58-112, Greenmount, Auckland Ph: +64 9-273 3727 Fax: +64 9-273 3726 Free Phone 0800 806 595	DRAWING TITLE		DATE	SHEET No.
	Corner Moulded Piece		JUNE 2005	W5
DRAWN	© Copyright		SCALE	
MKN			NTS	

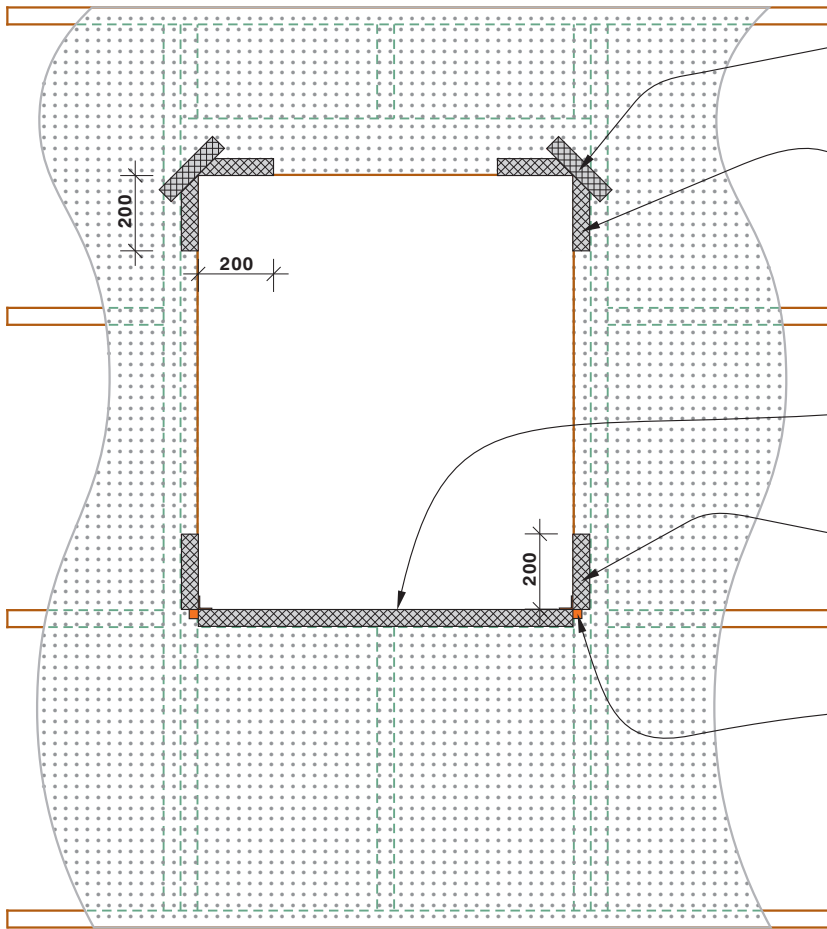

Thermakraft **ALUBAND** Window Sealing Tape

45° (100mm x 50mm) butterfly

Thermakraft **ALUBAND** Flashing Tape

3mm min. overhang at corner

Thermakraft **ALUBAND** Window Sealing Tape

to extend 200mm min. in both directions

Continuous Thermakraft **ALUBAND** Window Sealing Tape to sill (150mm or 200mm width)

Thermakraft **ALUBAND** Window Sealing Tape

to extend 200mm min. vertically on both sides of opening

Thermakraft **ALUBAND** Window Sealing Tape secured over Thermakraft **Corner Moulded Piece™** and Thermakraft **Cover-Up** (BRANZ Appraised) or Thermakraft **WaterGate** Building Wraps

Thermakraft **ALUBAND** Window Sealing Tape to extend 200mm min. vertically on both sides of opening

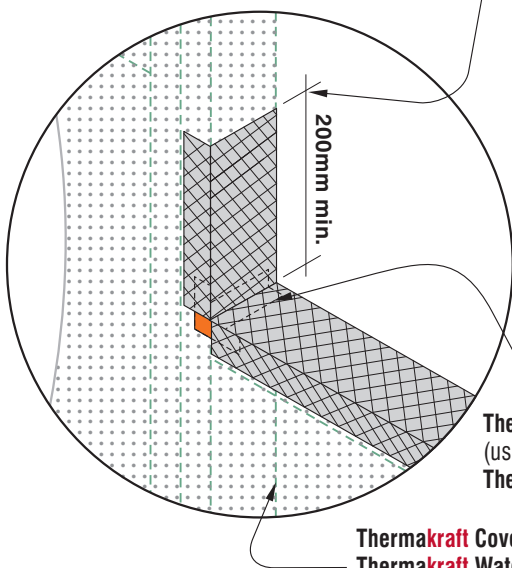

Thermakraft **ALUBAND** Window Sealing Tape (use 150mm or 200mm width) secured over Thermakraft **Corner Moulded Piece™**

Thermakraft **Cover-Up** (BRANZ Appraised) or Thermakraft **WaterGate** Building Wrap fixed to external face of framing

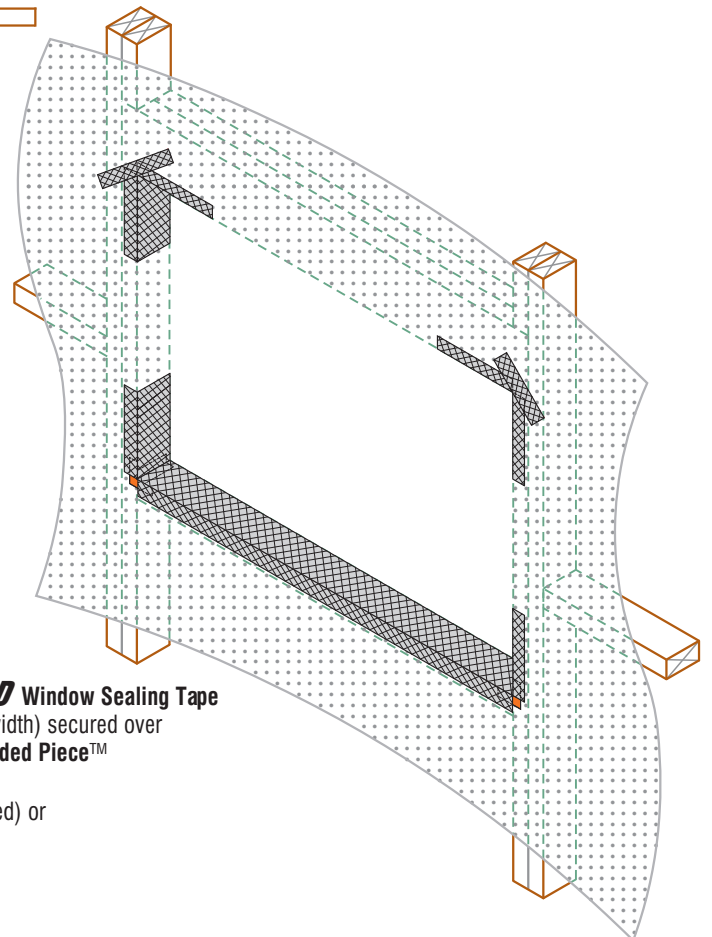

Thermakraft Industries (NZ) Ltd

11 Turin Place, Auckland
P.O. Box 58-112, Greenmount, Auckland
Ph: +64 9-273 3727 Fax: +64 9-273 3726
Free Phone 0800 806 595

DRAWING TITLE

Window Sealing Tape

DATE

JUNE 2005

SHEET No.

W6

DRAWN
MKN

© Copyright

SCALE
NTS

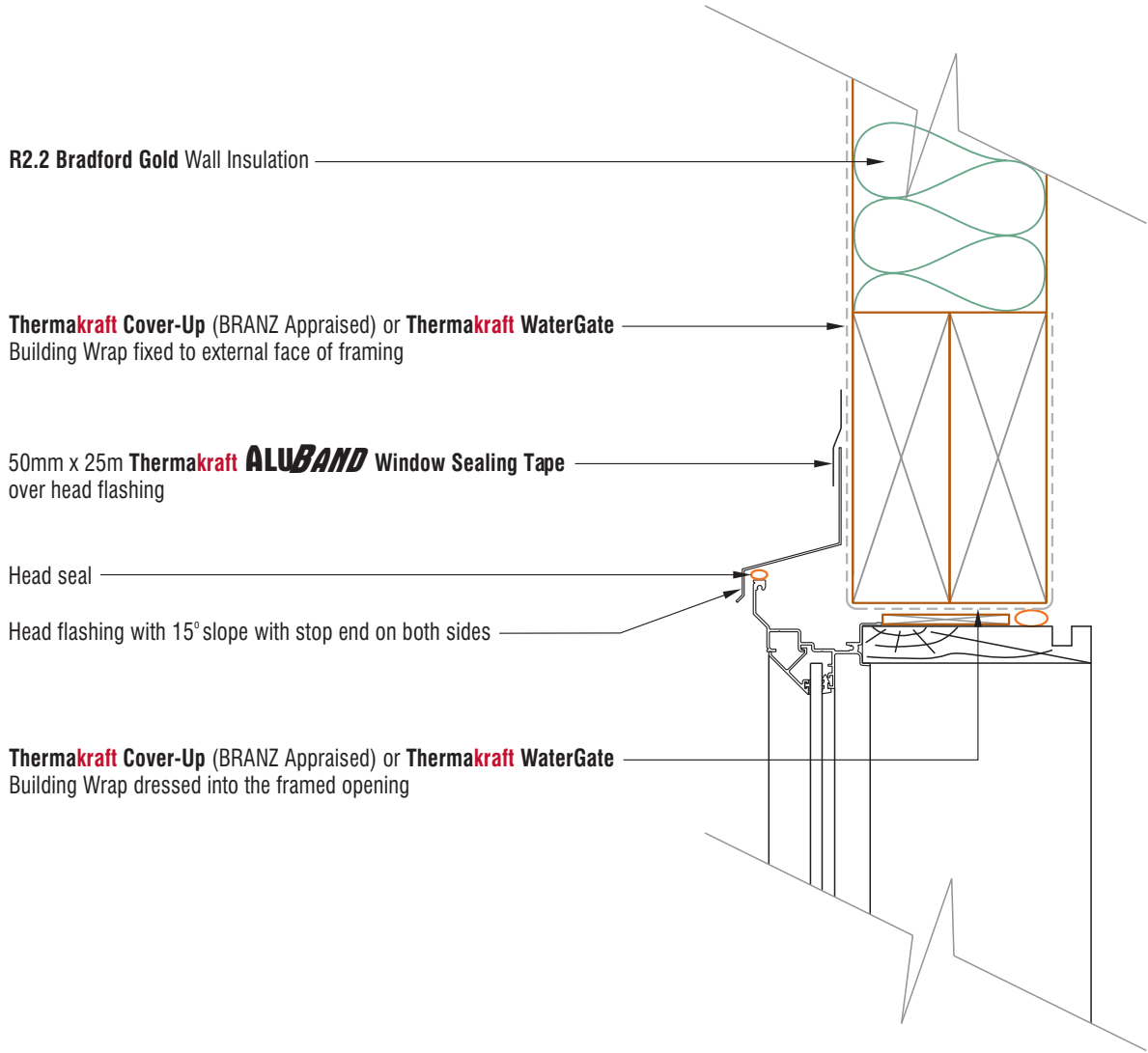

Thermakraft Industries (NZ) Ltd 11 Turin Place, Auckland P.O. Box 58-112, Greenmount, Auckland Ph: +64 9-273 3727 Fax: +64 9-273 3726 Free Phone 0800 806 595	DRAWING TITLE Window Sealing Tape		DATE JUNE 2005	SHEET No. W7
	DRAWN MKN	© Copyright	SCALE NTS	